

BENKAN[®]

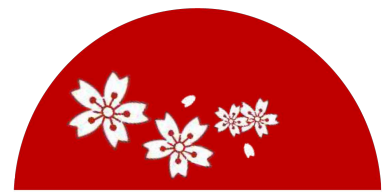

MADE IN JAPANTM

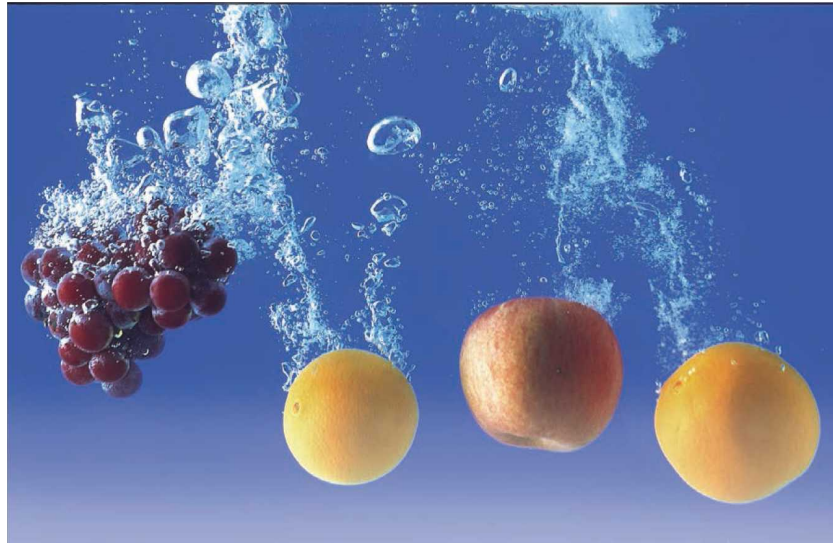

Press Fitting compatible with Stainless Steel Pipe BS EN 10312
不銹鋼卡壓式機械管件 BS EN 10312

MOLCOJOINTTM



BENKAN Corporation

Born in Japan

Contributing to the world's cleanest drinking water since 1975

源自日本，產自1975

為您提供世界級衛生標準的飲用水



Japan has seen a transition from copper pipe to stainless steel for the past 40 years. We at Benkan Corporation have been a manufacturer and provider of fittings compatible with stainless steel pipes ever since, and Japan has gained recognition for one of the cleanest potable waters in the world. Our next goal is to contribute to the global public health and water safety.

We proudly present our press fitting, Molco Joint, equipped with the essence of our knowledge and experience in waterworks.

經過40年的發展，日本國內的供水系統已由原來的銅水管為主逐漸轉變為現在的不銹鋼水管為主。BENKAN生產和銷售的不銹鋼卡壓式配管系統，在日本已經被認定達到世界級的飲用水衛生標準。我們的下一個目標是向世界提供安全的用水配管系統，確保全球用水公共健康。

在此，敝公司向您隆重推薦濃縮了所有技術精化和優良客戶體驗的不銹鋼卡壓式管件，Molco Joint。



Benkan has
40 years
of achievements
in stainless steel
plumbing
industry

BENKAN 擁有40年的不銹鋼供水系統的製造及安裝經驗

To say nothing of its strength and lightness, stainless steel is considered to be a clean and environmentally-friendly material for its high level of corrosion resistance and recyclability.

In addition, using our Molco Joint has the following advantages.

除高強度與輕量化之外，不銹鋼也被認定為是優秀的環保材料，有著高強度的抗腐蝕耐用性和可循環利用等特性。除此之外，Molco Joint還有以下優點。



Installation is fire-free and does not require any soldering materials that can be harmful to human beings.

安裝無需使用火，保證了現場的安全性，無需使用焊條保證了客戶的健康。

The press tool is easy to handle and drastically reduces the installation time.

卡壓工具易於操作，大大節省安裝時間。



Rigorously tested for strength and durability, enough to withstand frequent minor earthquakes in Japan.

經過嚴格的強度和耐久性試驗，在地震多發國家（如日本）亦可安心使用。

Specifications 規格

Structure

Molco Joint is compatible with stainless steel pipes conformed to BS EN 10312 Series1.

The fitting body is made from stainless steel (grade 304), with EPDM seal rings attached inside the grooves.

Once the pipe is inserted to an adequate depth, installation with Benkan press tools guarantees homogeneous and sufficient strength and water-tightness.

Molco Joint 管件由304不銹鋼做成，適用於BS EN 10312-1規格的不銹鋼配管。

將管子插入到管件的適當深度，使用BENKAN指定卡壓工具進行充分的卡壓，就會得到均勻和高效的抗拉伸和高防水的性能。

Standards

Molco Joint is tested to AS3688, and approved by the WSD

The seal ring is WRAS-certified (BS 6920) for use in contact with potable water.

Molco Joint 經過AS3688 測試。密封圈通過英國WRAS認證 (BS 6920) ，可安全使用在飲用水供水系統中。



Scope

Molco Joint can be used under the following conditions

Molco Joint 可使用於以下條件

Usage / 用途	Cool and warm drinking and utility water, fresh water for refrigeration, irrigation and other usages.
Operating Pressure / 工作壓力	16 bar (1.6MPa) and below.
Operating Temperature / 工作溫度	Below 80°C

*Not suitable for steam piping

*Please consult us for use with fluids other than listed above

*不適用於蒸汽配管

*如想用在上述用途以外的其它流體，請與本公司聯絡。



Metal Leaching

Molco Joint was tested to AS/NZS 4020:2005 Appendix H - Extraction of Metals, and registered as a low-metal-leaching GA* product.

(µg/L)

Metal Elements	Test water Blank	Test Result	Reporting Limit	WHO Limit
Chromium 鉻	<1.0	<1.0	1.0	50
Nickel 鎳	<1.0	<1.0	1.0	70
Copper 銅	<5.0	<5.0	5.0	2000
Cadmium 鎘	<0.20	<0.20	0.20	3
Antimony 銻	<0.30	<0.30	0.30	20
Lead 鉛	<1.0	<1.0	1.0	10

Authorized Press Tool

BPN-16R for 15, 22 & 28mm fittings

- Allows access to narrower spaces (10 mm) in comparison with the existing models.
- The LED indicator shows a detected system error, preventing unexpected accidents.
- 與其他型號相比，可以在更窄的空間操作 (10 mm)
- LED 指示燈顯示檢測到的系統錯誤，告知操作時出現異常情況。



RID318 for 35, 42 & 54mm fittings

- Fool-proofing designed spring lever to effectively prevent mishandling due to unlocking.
- High performance Lithium battery, 200 cycles of pressing after a single charging.
- LED Screen for easy to read work status.
- Automatically return to the start position after complete pressing.
- Error-proofing design for closing of pins of press jaws.
- 270° head swivel.
- 壓接鉗插銷設計有彈簧裝置，有效防止未鎖緊的誤操作。
- 高性能鋰電池，每次充電後可支持 200 個壓接週期。
- LED 顯示屏，方便讀取工作狀態。
- 完成壓接後自動返回起始位置。
- 鉗口安全插銷避免未鎖緊的誤操作。
- 270° 頭部旋轉。



Quick, Safe and Fire-free Installation with press tool



CUT

Cut the pipe to the desired length using a rotary cutter

建議使用旋轉切刀將管材切割到所需長度。



DEBURR

Remove any burrs around the pipe end to prevent damage to the seal ring

去除管端內外部多餘毛邊，以免對橡膠圈造成損傷影響密封。



MARK

Use the marking gauge (included in the press tool set) to mark the insertion depth on the pipe

用畫綫器(包含在工具套箱內) 在管子上進行標記，以免造成插入不充分的錯誤。

*The warranty does not cover leakage and other accidents arising from fittings installed without marking.

*保修不包括因沒有劃綫而造成的任何漏水和其它情況。



INSERT

Insert the pipe into the fitting to the marked depth

將管子插入到管件內，直到畫綫部位。

*Please do not use press tools not authorized by Benkan, as it may lead to an installation failure.

*Please select the correct jaw size for the fitting. (installation manual)

*請不要使用 BENKAN 認定的卡壓工具以外的工具進行施工。以防造成卡壓不合格。



PRESS

Press the fitting with the press tool approved by Benkan

使用BENKAN指定工具進行卡壓。

*Make sure the insertion length is sufficient. The line mark must be within 3mm from the fitting end.

*請確認黑綫記號在距離管件末端 3mm 範圍之內。



CHECK

Use the hexagonal gauge to check the dimension.

使用六角量規器確認卡壓作業是否完全到位。

*Please read the Molco Joint installation manual prior to construction.
*施工前請仔細閱讀施工手冊

Uncompromising Quality

Achieved through true craftsmanship and manufacturing

How Are Molco Joints Made? Molco Joints 的製作

Stainless steel tubes are processed into desired shapes by cold forming method. Tee is formed by the bulging method. Some parts are joined with TIG (tungsten inert gas) welding. The weld area is protected from oxidation with an inert shielding gas with a very smooth finish at the bead.

將不銹鋼管件用冷卻成型的方法做成想要的形狀。三叉 (Tee) 則是採用脹形法。其一部分用TIG焊接法 (鎢極惰性氣體保護電弧焊) 進行連接。因惰性氣體會防止焊接部分氧化並形成非常光滑的表面。

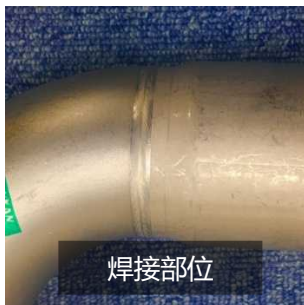

焊接部位

The fine finish of the weld (above) is obtained by TIG welding method (below). The smooth bead (welded area) is vital for the water flow.

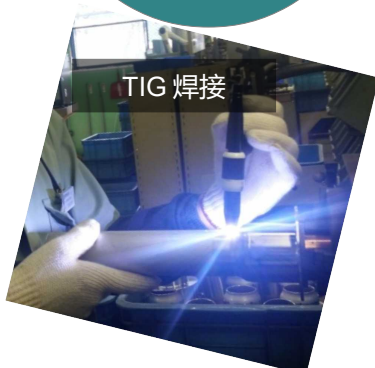

TIG 焊接

Thorough Quality Assurance 徹底的品質保障

The manufacturer's responsibility goes far beyond just production. Our skilled craftsmen run a minute visual check on every single joint to ensure the best quality. All welded fittings are examined for airtightness.

工廠的責任不僅是生產，我們經驗豐富的工人會一個一個進行檢查以確保最好的品質。焊接過的產品更是要通過氣密試驗。

Molco Joints are **100 %** visually examined by our craftsmen, all welded fittings checked for airtightness.



Molco Joints 是100 % 進行人工目視外觀檢查，所有焊接過後的產品都必須要進行密封試驗

Performance Tests 性能測試

Molco Joint meets all the performance requirements set by the Japan Stainless Steel Association (SAS322), as well as Australian Standard (AS3688).

Molco Joint 的所有性能標準都符合日本不銹鋼協會 (SAS322) 中所要求的標準，同樣也符合日本國內外其它的水質標準權威機構的要求。



伸拉測試

Pull-out test (above)
Accelerated degradation test (below)
Vibration test (bottom).



加速老化測試



震動測試

Fitting Lineup 產品目錄



90° Compact Elbow / 曲



90° Reducer Elbow
刁士曲



90° Plain-End Elbow
尖尾邊



45° Elbow / 曲



45° Plain-End Elbow
尖尾邊



Reducer / 刁士



Plain-End Reducer
尖尾邊刁士



Coupler / 梳傑



Slip Coupling
通關梳傑



Tee / 三叉



Cap / 喉口



Straight Adaptor with
Tapered Thread / 外牙咀 (M)



Straight Adaptor with
Tapered Thread (F) / 內牙咀



Adaptor Elbow with Tapered
Thread (M) / 外牙曲



Adaptor Elbow with
Tapered Thread (F) / 內牙曲

Specifications 規格

90° Compact Elbow / 90° 曲

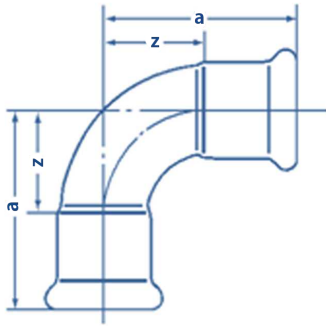

No.	Size 尺寸 (OD)	a	z
90CE15	15	41	20
90CE22	22	50	26
90CE28	28	54	30
90E35	35	88	62
90E42	42	113	83
90E54	54	139	104

90° Reducer Elbow / 90° 刁士曲

No.	Size 尺寸 (OD)	a	z
90E2215	22 x 15	59/48	35/27

90° Plain-end Elbow / 90° 尖尾邊

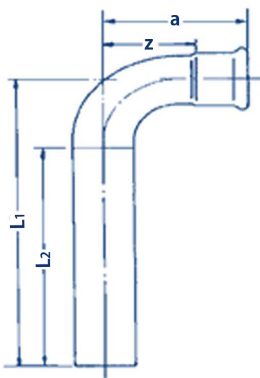

No.	Size 尺寸 (OD)	a	z	L1	L2
90SE15	15	48	27	120	100
90SE22	22	58	34	127	100
90SE28	28	66	42	135	100
90SE35	35	88	62	130	68
90SE42	42	113	83	160	77
90SE54	54	139	104	205	100

45° Elbow / 45° 曲

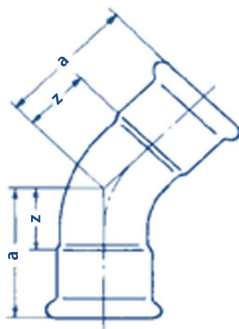

No.	Size (OD)	a	z
45E15	15	36	15
45E22	22	42	18
45E28	28	46	22
45E35	35	55	25
45E42	42	68	35
45E54	54	85	47

45° Plain-end Elbow / 45° 尖尾邊

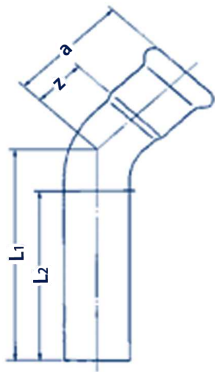

No.	Size 尺寸 (OD)	a	z	L1	L2
45SE15	15	36	15	113	100
45SE22	22	42	18	116	100
45SE28	28	46	22	120	100
45SE35	35	55	25	75	50
45SE42	42	68	35	105	70
45SE54	54	85	47	130	83

Reducer / 刁士

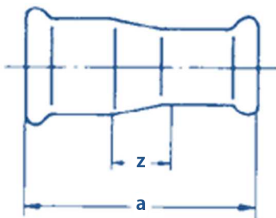

No.	Size 尺寸 (OD)	a	z
R2215	22 x 15	60	15
R2815	28 x 15	75	30
R2822	28 x 22	64	16
R3522	35 x 22	92	43
R3528	35 x 28	79	30
R4222	42 x 22	95	42
R4228	42 x 28	84	35
R4235	42 x 35	87	31
R5422	54 x 22	110	52
R5428	54 x 28	109	51
R5435	54 x 35	102	41
R5442	54 x 42	100	35

Plain-end Reducer / 尖尾邊刁士

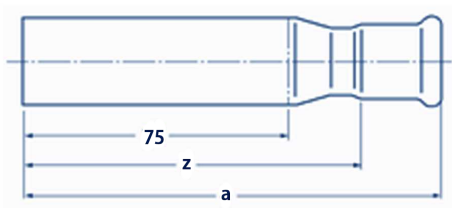

No.	Size 尺寸 (OD)	a	z
RP2215	22 x 15	106	85

Coupler / 梳傑

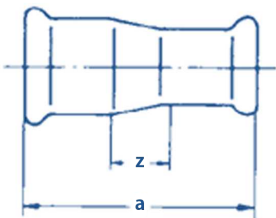

No.	Size 尺寸 (OD)	a	z
C15	15	53	11
C22	22	60	12
C28	28	60	12
C35	35	64	8
C42	42	74	10
C54	54	84	8

Slip Coupling / 通關梳傑



No.	Size 尺寸 (OD)	a
BS15	15	116
BS22	22	129
BS28	28	129
BS35	35	102
BS42	42	117
BS54	54	136

Tee / 三叉

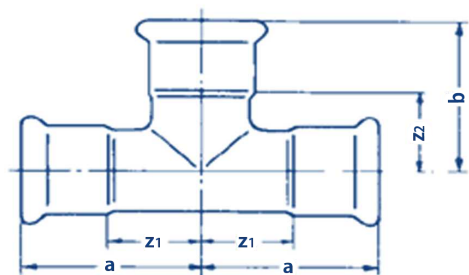

No.	Size 尺寸 (OD)	a	b	Z1	Z2
T15	15	38	38	17	17
T22	22	46	46	22	22
T2215	22 x 15	46	42	22	21
T28	28	51	51	27	27
T2815	28 x 15	51	53	27	32
T2822	28 x 22	51	51	27	27
T35	35	52	60	26	34
T3522	35 x 22	52	51	26	29
T3528	35 x 28	52	56	26	31
T42	42	59	65	29	35
T4222	42 x 22	59	55	29	32
T4228	42 x 28	59	61	29	36
T4235	42 x 35	59	63	29	37
T54	54	70	78	35	43
T5422	54 x 22	70	60	35	37
T5428	54 x 28	70	66	35	43
T5435	54 x 35	70	70	35	44
T5442	54 x 42	70	70	35	40

Plug / 喉口

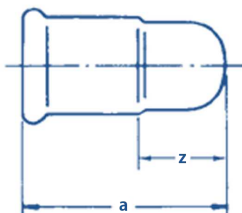

No.	Size 尺寸(OD)	a	z
P15	15	31	10
P22	22	42	18
P28	28	44	20
P35	35	49	23
P42	42	53	23
P54	54	60	25

Straight Adaptor with BSP tapered thread (Male) / 外牙咀

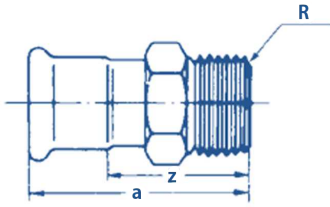

No.	Size 尺寸 (OD)	a	z
ASM1512	15 x 1/2	57	36
ASM2234	22 x 3/4	64	40
ASM281	28 x 1	68	44
ASM35114	35 x 1 1/4	95	69
ASM42112	42 x 1 1/2	95	65
ASM542	54 x 2	113	78

Straight Adaptor with BSP tapered thread (Female) / 内牙咀

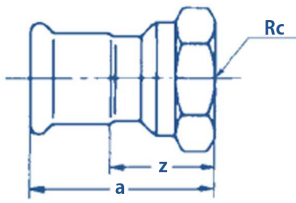

No.	Size 尺寸 (OD)	a	z
ASF1512	15 x 1/2	48	27
ASF2234	22 x 3/4	54	30
ASF281	28 x 1	57	33
ASF35114	35 x 1 1/4	80	54
ASF42112	42 x 1 1/2	79	49
ASF542	54 x 2	95	60

90° Elbow Adaptor with BSP tapered thread (Male) / 90° 外牙曲

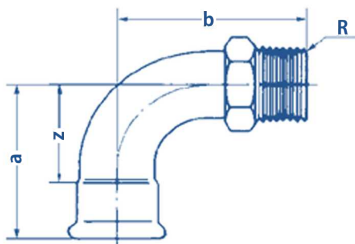

No.	Size 尺寸 (OD)	a	b	c
AEM1512	15 x 1/2	48	52	27
AEM2234	22 x 3/4	58	62	34
AEM281	28 x 1	66	73	42
AEM35114	35 x 1 1/4	88	110	62
AEM42112	42 x 1 1/2	113	143	83
AEM542	54 x 2	139	159	104

90° Elbow Adaptor with BSP tapered thread (Female) / 90° 内牙曲

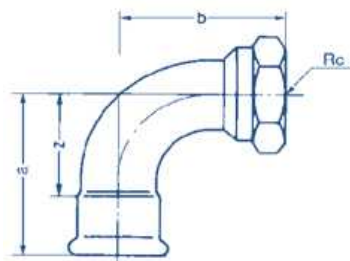

No.	Size 尺寸 (OD)	a	z
AEF1512	15 x 1/2	48	43
AEF2234	22 x 3/4	58	52
AEF281	28 x 1	66	62
AEF35114	35 x 1 1/4	88	85
AEF42112	42 x 1 1/2	113	130
AEF542	54 x 2	139	152

HOTO Stainless Steel Plumbing

不銹鋼喉管

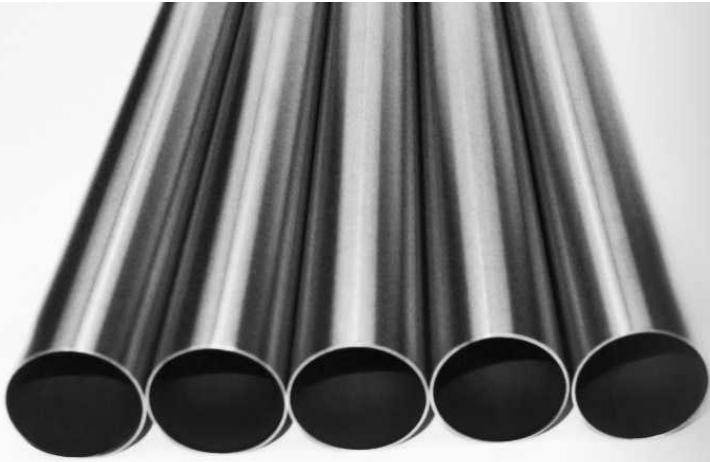

Why Choose Hoto Stainless Steel Plumbing?

The many advantages of stainless steel plumbing include:

- Low maintenance costs and other life-cycle costing advantages
- Does not demand water treatment chemicals, except for bacterial control
- Pipe work is unaffected by high water flow rates
- Able to sustain the full range of potable waters, including soft waters, a feature that is viable in large buildings
- Very good corrosion resistance, hence there is no danger of contamination of drinking water supplies
- Strong yet ductile
- Non-toxic
- Manufactured from a high proportion of recycled material and is 100% recyclable
- Suitable for hot water usage
- Looks good after installation

為何選擇 HOTO 不銹鋼喉管?

不銹鋼管眾多好處包括：

- 維修費低、具備使用周期費用低的優勢
- 細菌防治以外，無需使用化學物品處理水質
- 喉管不受水量高低影響
- 能負荷所有飲用水（包括輕水），也適用於大型建築
- 良好的防銹材料，不會污染飲用水供
- 堅固，可塑性強
- 無毒
- 採用高成分可再循環材料製造，可再循環率 100%
- 安裝整齊美觀
- 熱水器適用

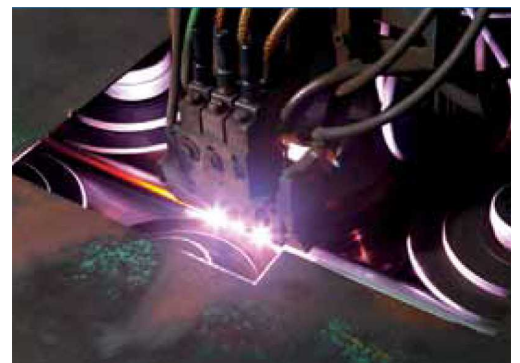

Reference Projects 工程項目

Japan



- Universal Studio Japan
- Tokyo Sky Tree
- New Chitose Airport
- Dogo Onsen
- Osaka Prefect. Hospital
- Tokyo Metropolitan Govt. (Clockwise from above)



Taiwan / Malaysia

- Taipei 101 台北101
- Kuala Lumpur International Airport 2 吉隆坡國際機場 2
- Petronas Twin Towers 雙子塔

Hong Kong

- Hong Kong West Kowloon Station 香港西九龍站
- Wan Chi Luard Road Refuse Collection Point 盧押道垃圾收集站

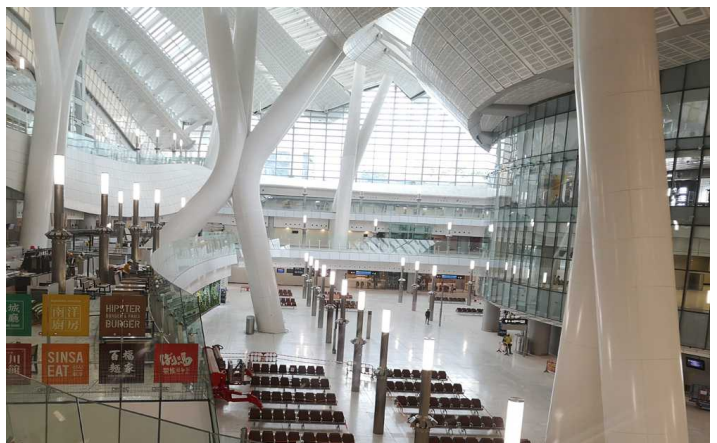



HEAD OFFICE	5-1. ROKUSENGOKU, OTA-CITY, GUNMA-PREF, JAPAN.
本社	群馬縣太田市六千石町5-1
OVERSEAS GROUP	3-1-18, NISHINAGASUCHO, AMAGASAKI-CITY, HYOGO-PREF, JAPAN.
海外營業組	兵庫縣尼崎市西長洲町3-1-18
	TEL: +81-6-6482-1856 FAX:+81-6-6482-1824

Our Authorized Distributor:

指定分銷商：

TACHIBANA ENGINEERING

立花工程(香港)有限公司

Tachibana Engineering (HK) Limited
立花工程(香港)有限公司

Unit C, 6/F, Reason Group Tower
403 Castle Peak Road, Kwai Chung
N.T., Hong Kong

香港新界葵涌青山道 403 號
匯城集團大廈 6 樓 C 室

Tel 電話 : 852-2403-4898
Fax 傳真 : 852-2403-4000
Email 電郵 : info@te.com.hk
Website : www.te.com.hk

*All information is current as of January 2019. We may make changes to specifications and product descriptions at any time.
*本目錄所有內容均為2019年1月的內容，因品質提高等有變更內容的可能